



# Installation Manual *for*

- **Corrugated Steel Pipe**
- **Pipe Arches**
- **Structural Plate**

## INSTALLATION MANUAL — NCSPA

---

The NCSPA Installation Manual is not a copyrighted publication. If excerpted or copied, credit to the source would be appreciated.

\* \* \*

The information contained in this Installation Manual is the product of industry experience and practice. The methods used to install corrugated steel pipe can affect both its effectiveness and useful life. The situations described in this publication and the suggested techniques for installation are general suggestions and guidelines intended to alert installers to the need for careful review of on-site conditions. Each installation will require its own individual evaluation. The statements or descriptions provided herein are for general information only. The National Corrugated Steel Pipe Association assumes no responsibility for their use.

\* \* \*



NATIONAL CORRUGATED STEEL PIPE ASSOCIATION  
1255 Twenty-Third Street, NW, Suite 200  
Washington, DC 20037-1174  
Phone: 202/452-1700 • Fax: 202/833-3636  
E-mail: [csp@ncspa.org](mailto:csp@ncspa.org) • Web: [www.ncspa.org](http://www.ncspa.org)

# TABLE OF CONTENTS

---

<b>FOREWORD</b> .....	3
<b>BASIC PRINCIPLES FOR PROPER CONSTRUCTION AND INSTALLATION</b> .....	4
<b>LOCATION</b> .....	5
<b>EXCAVATION</b> .....	5
Embankment Condition .....	5
Trench Condition .....	5
Trench Width and Shape .....	6
<b>PREPARING FOUNDATIONS</b> .....	7
Handling Poor Foundations .....	7
Uneven Foundations .....	8
Soft Foundations .....	9
Pockets of Unstable Soil .....	9
Swampy Foundations .....	10
Improved Foundations .....	10
Settlement Under High Fill Loads .....	10
Rock Foundations .....	11
Arch Foundations .....	11
<b>ASSEMBLY</b> .....	12
Unloading and Handling .....	12
Connecting Bands .....	12
Installing Connecting Bands .....	12
Typical Connecting Bands .....	14
Gaskets .....	16
Mastic .....	17
Asphalt Coated Pipe .....	17
Paved-Invert Pipe .....	17
Full Lined Pipe .....	18
Polymer Coated Pipe .....	18
Pipe Arch .....	18
Field Coated Structural Plate Structures .....	18
Structural Plate Structures .....	18
Tools Required .....	19
Erection .....	19
Long Span Structures .....	21
Lifting Assistance .....	21
End Treatment .....	21
Cut End .....	22

**ASSEMBLY** *(continued)*

Cut-Off Walls .....	23
End Sections .....	24
Other End Finishes .....	24
Stream Diversion .....	24
<b>BACKFILLING</b> .....	25
Backfill Material .....	25
Placing the Backfill .....	25
Pipe Arches .....	30
Arches .....	30
Large Diameter Structures .....	32
Proper Material Placement .....	32
Even Placement of Backfill .....	33
Shape Control .....	33
Multiple Installations .....	34
Long Span Structures .....	35
Final Backfilling .....	35
<b>COMPACTION EQUIPMENT</b> .....	35
Hand Compaction .....	35
Mechanical Compactors .....	36
Roller Compactors .....	36
Vibrating Compactors .....	36
Hydraulic Compaction .....	36
Structure Protection .....	36
Construction Loads .....	37
Hydraulic Protection .....	38
<b>SUMMARY</b> .....	40
<b>SUBDRAINAGE</b> .....	41
Underdrain Pipe .....	41
Flow Line .....	41
Preparing the Foundation .....	41
Assembly of Underdrain Pipe .....	41
Proper Placement of Underdrain Pipe .....	42
<b>APPENDIX</b> .....	44
Culvert Grades and Outfall Treatment .....	44
Length of Culverts .....	44
Skew Number .....	47

## FOREWORD

---

This manual is intended for both the contractor and the engineer. It provides practical information for the installation of corrugated steel pipe as storm sewers or culverts. It also provides the necessary considerations for proper design to achieve long term performance of the culvert or storm sewer.

Corrugated steel pipe with its high load carrying capacity, strong joints and exceptional beam strength is installed more easily than other types of conduit. However, *the correct installation procedures must be followed to insure full investment value in the structure.*

**It is the intent of this manual to suggest ways and means of improving installation practices. It is not intended to be used as a direct specification, but rather as a practical field guide for the installation of corrugated steel pipe, pipe arch and structural plate.**

**Too much emphasis cannot be placed on the necessity of adequate compaction of backfill. Faulty compaction has led to more trouble with pipe installations, flexible and rigid, than all other factors combined!**

OSHA safety regulations and guidelines must be observed during all phases of construction including foundation preparation, excavation, pipe handling, assembly and backfilling.

Additional information is available in the *AISI Handbook of Steel Drainage and Highway Construction Products* and ASTM Specifications A 798 and A 807.

This manual uses dual units of measure with Imperial units shown first followed by metric units in parentheses. Complex drawings or tables may be duplicated in metric.

## BASIC PRINCIPLES FOR PROPER CONSTRUCTION & INSTALLATION

---

Project plans and specifications provide the basic requirements for construction and installation. However, site conditions often vary from those anticipated during design. The contractor and construction engineer must recognize these variations. Often, alternate or additional construction considerations are necessary. The following guidelines provide specific considerations and details for various conditions in a step-by-step construction sequence.

The following summary will appear again near the end of the manual. However review it now as a basic outline of the steps required for a proper installation:

- 1) Check alignment in relation to the plans as well as the actual site conditions.
- 2) Make certain the pipe length(s), necessary appurtenances, etc. are correct.
- 3) Excavate to the correct width, line and grade.
- 4) Provide a uniform, stable foundation—correct site conditions as necessary.
- 5) Unload, handle and store the pipe correctly.
- 6) Assemble the pipe properly—check alignment, follow special procedures for the connecting bands, gaskets, and other hardware used. (For structural plate structures, achieve properly aligned plate laps, bolt torque, and assembled dimensions.)
- 7) Use a suitable (granular) backfill material as required in the plans and specifications.
- 8) Maintain proper backfill width.
- 9) Haunch the pipe properly.
- 10) Place and compact the backfill in 6 to 8 inches (150 to 200 millimeters) of thickness of compacted lifts.
- 11) Install the necessary end treatment quickly to protect the pipe and your efforts.
- 12) Protect the structure from heavy construction equipment loads, other heavy loads and hydraulic forces.

## LOCATION

---

Before installing any drainage structure, it is best to first recheck the planned alignment and grade (position and percent of slope) of the pipe in relation to the topography of the site. Even when complete construction plans are supplied, a careful examination of the site should be made.

## EXCAVATION

---

### Embankment Condition

The only excavation typically required for an embankment condition is to remove the topsoil, muck and organic matter and prepare a stable foundation at the proper elevation and grade.

### Trench Condition

Most storm sewers are installed in trenches. Although pipes can be easily installed in a trench, there are some general guidelines that should be followed.

All trench excavation should proceed only after OSHA and other safety requirements are met. Trench excavation normally proceeds in the upgrade direction. Most trenching equipment is more efficiently operated in this manner, and pipe sections are also more easily joined when progressing in this direction. If excavated spoil is to be used as backfill, it should be stockpiled at a safe distance from the edge of the trench. As a general rule, when trench walls are unsupported, the distance from the trench edge to the toe of the stockpiled material should not be less than one-half the depth of the trench. When trench walls are protected by some form of sheeting or shoring, a safe minimum distance between the trench edge and stockpiled material must still be maintained, but will vary with soil and bracing types.

Care should always be exercised in the operation of equipment in the vicinity of an open trench. Operated too close to the trench, equipment weight and vibration may collapse the trench walls. The three phases of construction in a trench (excavation, pipe installation, and backfilling) should be scheduled in close sequence with each other. An open trench is dangerous and vulnerable to accidents. An open excavation can result in damage to the project under construction. The two main hazards that must always be considered in trenching work are:

- Stability of trench walls; and
- Water that may accumulate in the trench resulting from seepage and surface runoff.

To minimize accidents and losses resulting from trenching operations the following procedures should be followed:

- Begin excavation only when installation of pipe can immediately follow.
- Protect trench walls to insure their stability throughout the construction period.
- Follow procedures that will keep the trench free of seepage and surface waters.
- Excavate the trench at the same rate as pipe installation with a minimum distance, as dictated by safety, separating the two operations.
- Backfill the trench as soon as practicable after pipe installation.

### Trench Width and Shape

The width and shape of the trench should be as shown on the plans. Any change should be approved by the Engineer.

Generally, the trench width will be specified as 12 to 48 inches (300 to 1200 millimeters) wider than the pipe. However, it must be wide enough to allow the critical lower quadrants of the pipe to be properly backfilled (haunched). Figure 16 provides guidelines about minimum spacing between multiple structures. These same guidelines can be used to provide the necessary width between the pipe and trench wall to adequately place typical backfill. Lesser spacing may be used with slurries and other backfill materials that do not require mechanical compaction.



## PREPARING FOUNDATIONS

---

Foundation requirements should be detailed on the plan sheets. However, field conditions often vary requiring special attention and alterations that are discovered only during excavation. Any alterations should first be approved by the Engineer.

Although corrugated steel drainage structures can experience some uneven settlement without disjointing or breaking, they should be placed on a firm, uniform foundation for best performance and long service life.

All storm sewers and culverts must be installed with the area under the haunches well compacted and all voids filled.

For corrugated steel pipe, the most popular method of preparing the foundation is by excavating to a flat surface and then carefully tamping the fill under the haunches of the pipe. Proper backfill density can be achieved by compacting the soil with a wooden pole, 2 x 4, or the smaller sizes of pneumatic tampers to eliminate all voids under the structure. See Figure 1 for typical methods of bedding corrugated steel structures and the 2 x 4 description.

This “flat foundation” technique works well except for larger pipe-arches and horizontal ellipses. The vee-shaped bedding technique for these structures is shown in Figure 12.

All pipe must be placed on stable earth or fine granular foundation. Never install them on sod, frozen earth or on a bed that contains large boulders or rock. When poor foundations with low bearing strength are encountered, investigate the possibility of a change in pipe location. Otherwise, it may be necessary to stabilize the poor foundation by a method described in the next section.

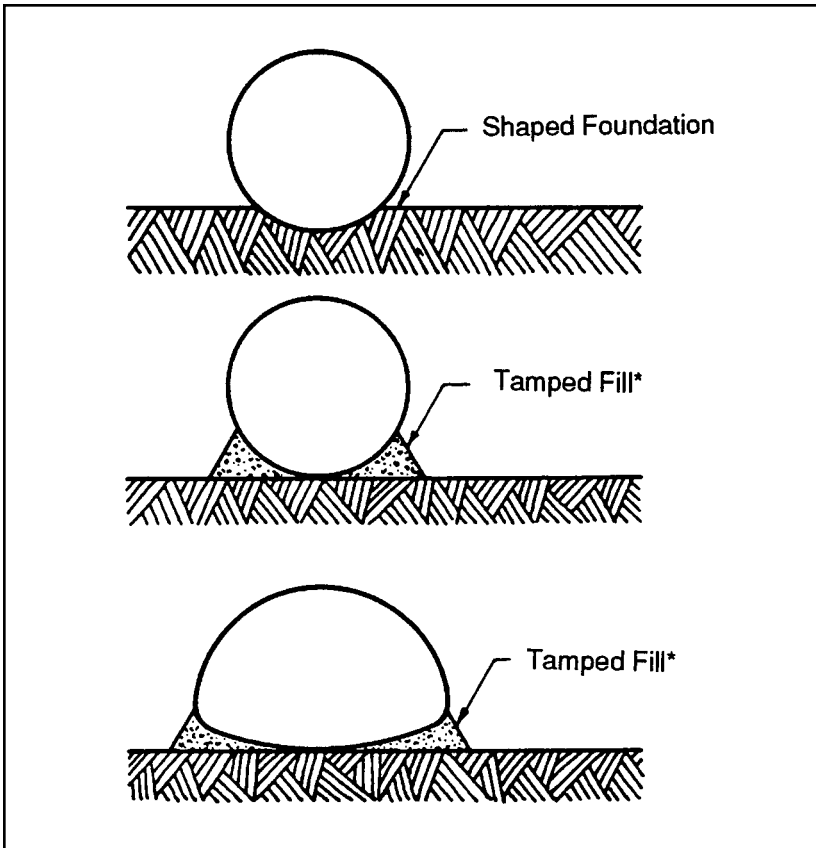
*Care must be taken to prevent water leaking through the fill or along the pipe.* When granular materials have been added for bedding, the ends of the fill should be sealed against infiltration. This can be done by bedding the ends in well compacted clay or by adding some type of end treatment such as an end section or a cut off wall.

### Handling Poor Foundations

If poor or non-uniform foundations are encountered, they must be treated correctly to assure satisfactory results. The critical factor is to achieve uniformity along the pipe with a tendency for the foundation to yield under the pipe in relation to alongside the pipe.

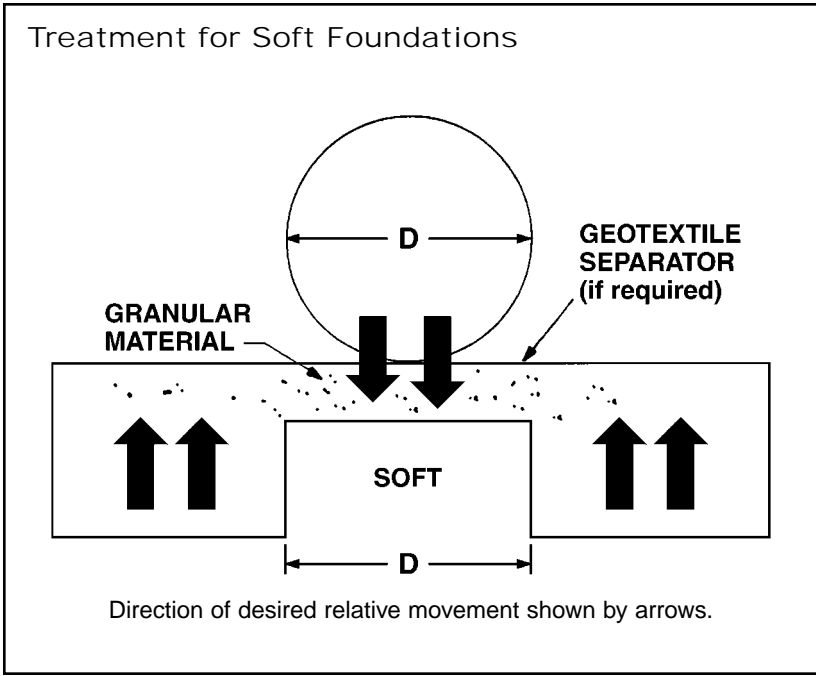
## Uneven Foundations

When the excavated grade line reveals both soft and hard spots, the foundation must be changed to make it as uniform as possible. Sometimes hard spots can be excavated below grade and replaced with softer material. Alternatively, it may be more economical to excavate the entire foundation slightly below grade line and replace it with suitable, uniform material. In any event, any abrupt changes from hard to soft foundation must be avoided.



**Figure 1.** Methods for attaining proper compaction under haunches of CSP and pipe-arch.

**\*Note:** When tamping with a 2 x 4, the designation of 2 x 4 will remain in usage as a descriptive expression without conversion to metric. It represents an approximate lumber cross-section of 40 by 90 millimeters.



**Figure 2.**

## Soft Foundations

When soft, unstable material is encountered at the foundation level, it must be excavated below the flow line grade and backfilled to grade with sand, gravel, crushed stone or other suitable material. The zone of select material must be adequate to support the pipe and backfill. When unexpected materials are encountered, consult the Engineer.

## Pockets of Unstable Soil

If unstable foundation material is in small pockets, it is best to excavate all of the poor foundation and replace it with suitable backfill material. Frequently, a relatively thin mat of granular material will provide satisfactory support, but it may be necessary to replace very soft foundations to a depth great enough to support not only the pipe, but also the heavier backfill placed beside it.

## Swampy Foundations

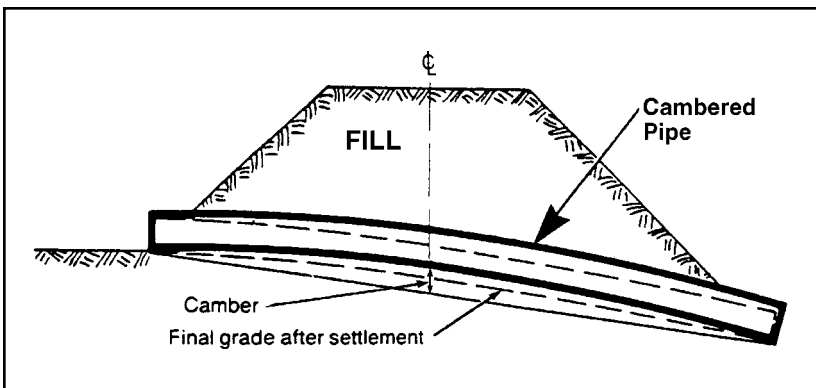
Corrugated steel pipe must not be placed in direct contact with pipe bents or concrete cradles that are installed to help provide a foundation. Such supports, if used, should be built with a flat top and covered with an earth cushion. In this way the flexible structure can develop side support without concentrating the load at any point.

## Improved Foundations (soft, uneven, unstable or swampy)

Whenever a foundation is stabilized by using a coarse granular material, consideration of the bedding and backfill material becomes even more important. Fine materials can migrate into coarser materials and geotextile separators are often required to prevent this migration.

## Settlement Under High Fill Loads (camber for embankment installations)

Cambering the center part of the foundation will compensate for unequal settlement under the weight of heavy embankments. This assures proper grade after settlement and prevents the structure from sagging in the middle as the foundation consolidates. Generally, sufficient camber can be obtained by installing the upstream half of the pipe on a flat grade and the downstream half on steeper than normal grade as shown in Figure 3. If camber is considered necessary based on foundation soil conditions, the amount of camber



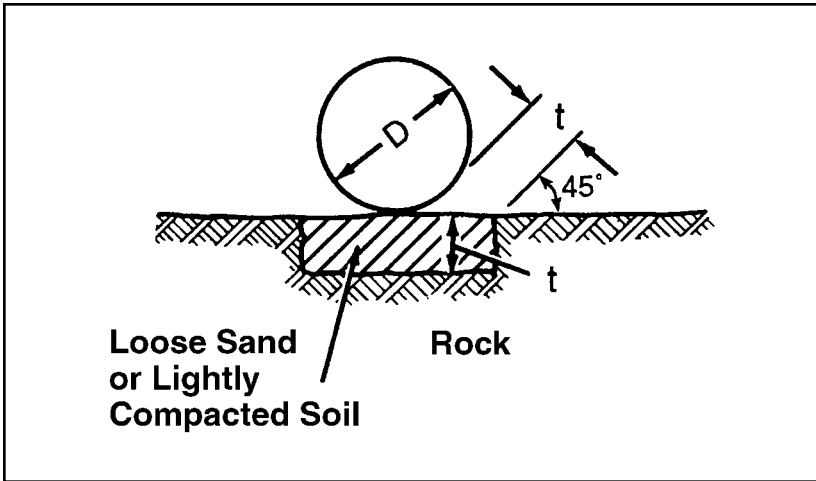
**Figure 3.** Correct method of cambering pipe to compensate for unequal settlement under high fills. Should be in accordance with procedure given in the *AISI Handbook of Steel Drainage and Highway Construction Products*.

must be determined by a qualified soils engineer. If the pipe is setting on cushioned rock or other adequate strength foundation, no camber is necessary, as settlement will be minor.

Be careful not to raise the center of the pipe above the inlet, as this will pocket water in the pipe.

## Rock Foundations

Rock encountered in the foundation must be removed to provide more than the minimum bedding thickness underneath the bottom of the structure. Excavate wide enough to avoid any possibility of the pipe resting on rock and provide access to adequately haunch the pipe as shown in Figure 4. The excavated area is then backfilled with compacted, granular soil to cushion the pipe.



**Figure 4.** Method of handling rock foundations.  $t = 1/2$  inch (13 millimeters) per foot (.30 meter) of fill over pipe, with 24 inches (.60 meter) the maximum.

## Arch Foundations

Arches differ from other structural plate structures in that they are generally erected on concrete foundations. The key way or unbalanced channel in which the arch rests must be accurately built to the proper line, grade and spacing for easy assembly of the plates. The unbalanced channels must be carefully located to insure that the holes correctly align with those in the plates to permit bolting. They must be properly oriented (angled) to receive the plate.

## ASSEMBLY

---

### Unloading and handling

***Pipe must never be dumped directly from a truck bed while unloading.***

Although corrugated steel drainage structures withstand normal handling they should be handled with reasonable care. Dragging the pipe at any time may damage the coatings. Also avoid striking rocks or hard objects when lowering pipe into trenches.

Since corrugated steel pipes are relatively light weight, they can be handled with light equipment. Use of slings is recommended to properly handle the pipe.

### Connecting Bands

The usual method of joining two or more lengths of pipe or pipe arch is by steel connecting bands. The bands engage the ends of each pipe section. They are placed to overlap each pipe section equally. The corrugations on the band must fit into the corrugations of each pipe. Tightening of bolts draws the band tightly around the adjacent ends of pipe lengths, providing an integral and continuous structure.

One piece bands are used for most installations of smaller sizes of pipe. “Two-piece” bands are used on larger diameter pipe and when installation conditions are difficult. “Rods and Lugs” are used on levees, aerial sewers and similar installations where bands that provide tighter and stronger joints are essential.

Typical bands, and their method of installation, are illustrated in Figures 4A to 4E. Specially fabricated bolted, welded or riveted connectors can be supplied for use in jacking and for special or unusual conditions. If the pipe ends have been match marked by the fabricator, then they must be installed in the proper sequence.

### Installing Connecting Bands

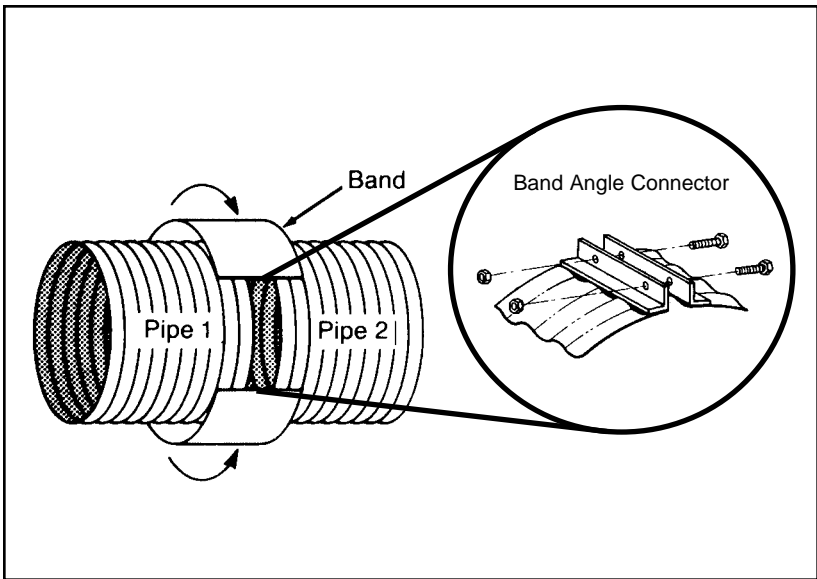
During the construction of a corrugated steel pipe system, care must be given to the assembly of joints to control both infiltration and exfiltration. Both processes will have an effect upon backfill materials since soil particle migration can occur. This is particularly true when fine “rained soils (fine sands and silts) are present in the backfill material. When necessary, a gasket, a geotextile wrap, or both can also be used to control infiltration of fines.

Bands are put into position at the end of one section of pipe with the band open to receive the next section. The next section is brought against or to within 1 inch (25 millimeters) of the first section. After checking to see that connecting parts of both band and pipe sections match, that the interior of bands and exterior of pipe are free of dirt, stones, etc., bolts are inserted and tightened.

To speed the coupling operation, especially for large diameter structures, a cinching device will help draw the band up tight. Special coupling devices can be used to fit over the connecting bands and quickly draw them together. Advantage of these devices is that they permit faster hand-tightening of the bolts, so that a wrench is needed only for final tightening.

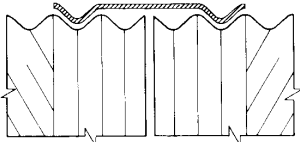
On large diameter pipe and asphalt coated pipe, merely tightening bolts will not assure a tight joint, due to the friction between the band and the pipe ends. In such installation, tap the band with a mallet to take up the slack as the band is tightened.

The wrench used to tighten coupling bands may be a deep socket or ratchet wrench for greater speed.

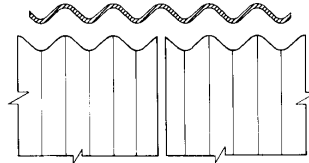


**Figure 4A.** Typical connecting band is wrapped around the joint and drawn together.

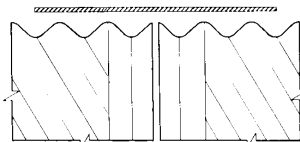
### Standard Couplers



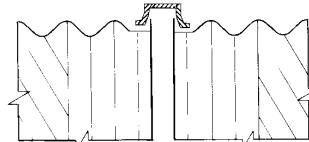
**Semi-Corrugated (Hugger)**



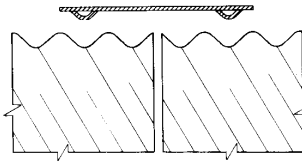
**Corrugated (Annular)**



**Flat**



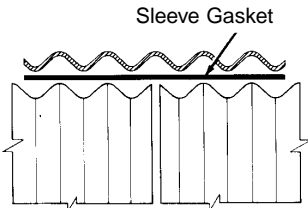
**Hat**



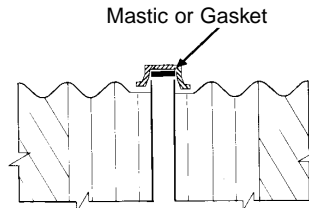
**Universal\***

\*Unless a dimple fills each corrugation valley, a suitable gasket or geotextile wrap is required

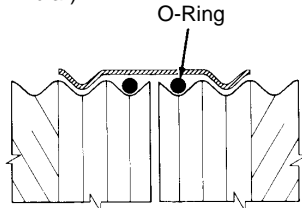
### Gasketed Couplers



**Corrugated (Annular)**



**Hat**



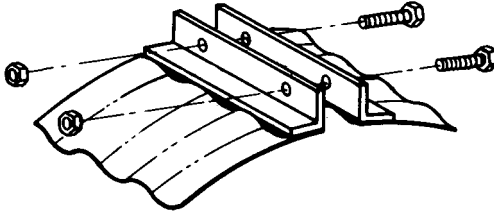
**Semi-Corrugated (Hugger)**

Figure 4B. Standard and Gasketed couplers for corrugated steel pipe.

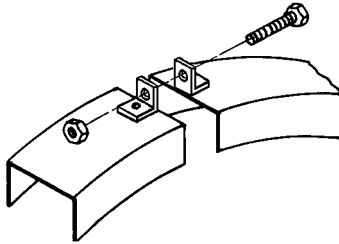


## Standard CSP Band Connectors

### Band Angle Connector



### Clip or Lug Angle Connector



### Bar and Strap Connector

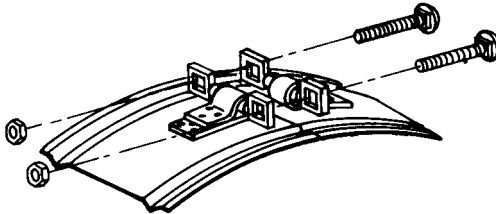


Figure 4C. These typical band connectors are used with CSP coupling systems.

When required, connecting bands can be furnished with gaskets or mastic as follows:

### Gaskets

Closed cell rubber, butyl rubber, neoprene, or closed cell rubber sponge gaskets are the basic types of materials to provide:

- (1) "O" ring gaskets which are recessed in a corrugation and then confined by the band after the joint is completed,
- (2) flat gaskets placed on each end of the pipe forming a joint and confined by the connecting band,
- (3) a flat sheet gasket placed over the ends of both pipes,
- (4) a gasket that is normally placed in the channel of the flanged band connector.

For all field installed gaskets, a smooth round rod should be inserted under the gasket and run around the circumference two or three times to equalize the stretch in the gasket. On asphalt coated pipe it may be necessary to clean the gasket groove to properly seat the gasket. The alignment and assembly of the pipe sections is extremely important when gaskets are used. A lubricant must be applied to the gasket for proper installation as recommended by the manufacturer. When a tightness test is required for final acceptance, the contractor should conduct his own test after a few joints are assembled as a check of his assembly methods.

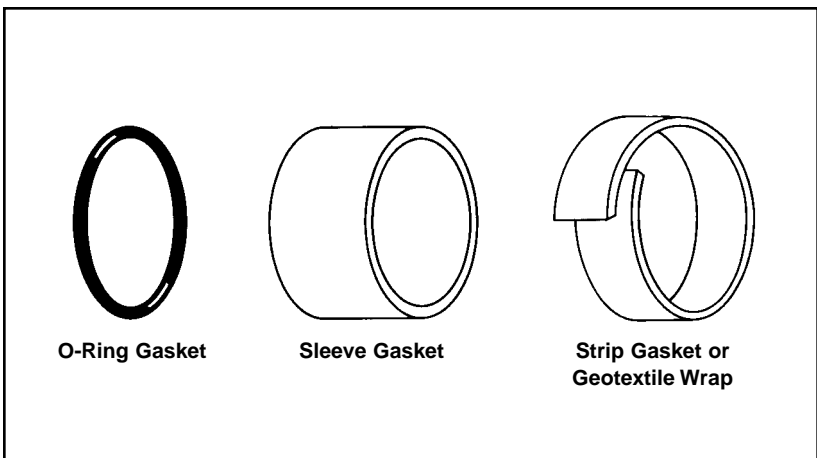


Figure 4D. Typical gaskets for use with connecting bands (where required).

## Mastic

Mastic may be applied to the connecting band or pipe prior to placing and tensioning the connecting band. A sufficient amount of mastic should be used to fill the joint space between the corrugation and band with some squeeze out.

## Asphalt Coated Pipe

Although asphalt coated corrugated pipe is laid and jointed in the same manner as galvanized pipe, special attention should be given to attaching the connecting bands. Contacting surfaces of the bands and pipe may need to be lubricated. This allows the band to easily slip around the pipe so it can be drawn more firmly into place. Lubrication is especially needed when surfaces are cold. In addition, tapping the bands with a mallet during tightening will help to assure proper joints.

## Paved-Invert Pipe

Pipe with an invert pavement must be stored and installed with the smooth, thick pavement in the bottom. Otherwise installation of paved-invert pipe is the same as for galvanized corrugated steel pipe.

If damage to the coating exposes the galvanizing, such areas must be patched with asphalt or bitumen before the structure is backfilled.

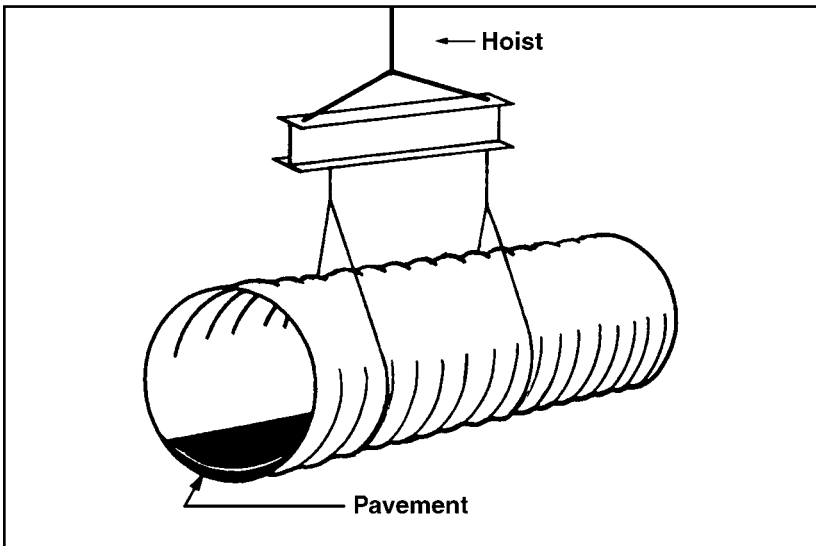


Figure 5. Handling a section of large diameter pipe with sling.

## Full Lined Pipe

100% paved pipe is basically an extension of the paving in paved invert pipe to include the entire periphery. Since the paving covers all interior corrugations, the pipe should not be subjected to rough handling. Smooth steel lined pipe is fabricated with smooth steel liner suitably coated.

When installations are to be made in hot weather, pipe lengths can be ordered with an additional white coating on the pipe exterior to reduce the temperature of the pipe, if it is to be exposed to the bright summer sun for long periods. Prolonged storage of fully lined pipe should be avoided in any season.

## Polymer Coated Pipe

Polymer coated pipe shall be installed in the same manner as asphalt coated pipe. Lubrication is not required unless gaskets are used.

## Pipe Arch

Corrugated steel pipe arch structures are installed in the same manner as round pipe. Recommendations regarding placement and connecting of various types of pipe also apply to pipe-arch. However, because of its shape, particular care should be taken in installing pipe arch structures. (See page 30.) Because of their multiple radius shape, pipe arches are not intended for restrictive leakage or high cover applications.

## Field Coated Structural Plate Structures

Field coated asphalt mastic coatings shall be applied per the manufacturer's application instructions and material safety data sheet (MSDS).

The coating shall be applied to a clean surface, free of dirt, oil, grease, or other foreign matter, when the atmospheric temperature is above 40°F (4°C), and the humidity is low enough that the surface of the metal can be kept dry.

Coating may be applied by spray, brush, or trowel as required by the manufacturer to attain a uniform dry thickness of 0.05 inch ( 1.3 millimeters).

## Structural Plate Structures

The primary difference between structural plate and factory fabricated pipe is that structural plate is assembled by bolting together fabricated corrugated steel plates at the installation site. Trucks usually deliver the stacks of curved plates to the site and equipment is required to lift such stacks intact. Individual plates may be removed and positioned with light equipment.

Preparation of the base and backfilling are the same as those described for corrugated steel pipe.

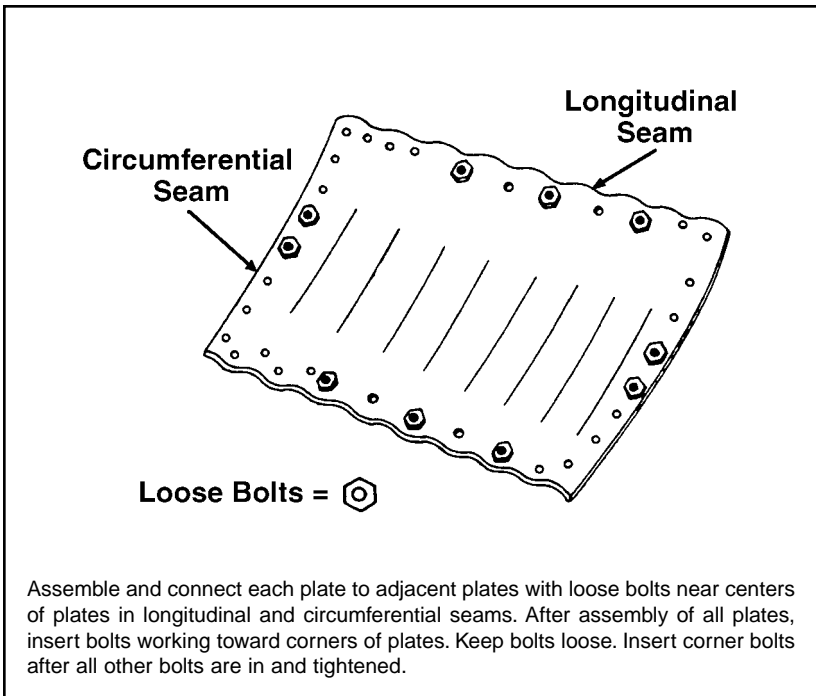
## Tools Required

Proper tools will speed the erection of structural plate. They include structural and socket wrenches, lining bars, drift pins and handling hooks.

If power wrenches are used, check bolt tightness very carefully as it is easy for these wrenches to get out of adjustment. The proper use of a long handled structural socket wrench or torque wrench will insure that bolts are properly tightened.

## Erection

Every structural plate structure is shipped complete with all necessary plates, bolts and nuts for erection. Inside one of the containers of bolts (clearly marked) are detailed erection instructions, showing the position of each plate and order of assembly.



**Figure 6. Method of placing structural plate bolts.**

Structural plate structures should be assembled with as few bolts as possible until all plates are in place. Three or four “finger tight” bolts placed near the center of each plate along the longitudinal and circumferential seams are sufficient. (See Figure 6.)

After several rings (a ring is a circumferential series of plates required to make one continuous circle) have been assembled, the remaining bolts can be installed, but not torqued tight, always working from the center of a seam toward the corner of the plates. Do not insert corner bolts until all others are in place and tightened. Aligning bolt holes with a bar is done more easily when the bolts are loose. Drifting, with a drift pin, is best done when the adjacent bolts are tight.

Tighten nuts progressively and uniformly, starting at one end of the structure, after all plates have been assembled. Then repeat the operation to be sure bolts are tight. From 100 to 300 foot-pounds (140 to 400 newton-meters) of torque should be applied. Do not over torque.

A good plate fit is far more important than high bolt torque. Some structures require alternate procedures—refer to the manufacturer’s assembly instructions.



**Figure 7.** Modern erection techniques are used in assembling structural plate.

## Long Span Structures

Long span structures are large structural plate pipes or arches to which general structural plate assembly requirements apply. However, because of their size, the plates need to be tightly bolted as they are placed. Because much of the strength of these structures is derived from their shape, the rise and span of the assembled shape must be within 2 percent of the design dimensions prior to backfilling. With any long span structure, the manufacturer should cover specific requirements in a pre-construction conference.

## Lifting Assistance

Generally speaking, if the diameter or rise of the structural plate structure is beyond the extended arms of the average construction worker, he should be provided some type of lifting equipment or scaffolding. If powered lifting equipment is not feasible or readily available, here are other ways of simplifying assembly:

1. An “A” frame, utilizing man-powered block and tackle.
2. A lifting hoist built into the bed of a flat-bed truck.
3. Bed of a flat-bed truck, if size of structure permits the truck to be driven inside.
4. A combination of scaffolding built inside the structure and ladders outside. Or a flat-bed truck plus scaffolding.

## End Treatment

In many cases, the ends of corrugated steel pipe that project, through the embankment can be simply specified as square ends, that is, not beveled or skewed. The square end is lowest in cost and readily adaptable to road widening projects. For larger structures, the slope can be warped around the ends to avoid severe skews or bevels on the pipe end in many cases. When desired for hydraulic considerations, flared end sections can be furnished for shop fabricated pipe. Such end sections can be bolted directly to the pipe.

When specified, ends of corrugated steel structures can be cut (beveled or skewed) to match the embankment slope. However, cutting the ends destroys the ability of the end portion of the structure to resist ring compression and uplift forces. Thus, ends with severe cuts must be reinforced, particularly on larger structures. For complete details, see the *AISI Handbook of Steel Drainage & Highway Construction Products*.



**Figure 8. End Treatment.**

End treatment must be constructed as shown in the plans and specifications. End treatment should be completed as quickly as possible to avoid problems and structure damage if a storm or other circumstance should arise.

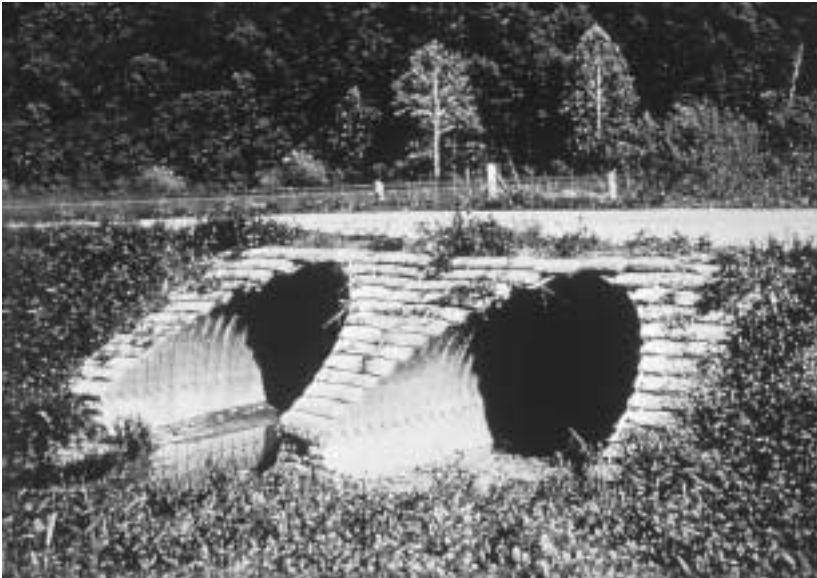
### Cut Ends

By cutting the ends of corrugated steel structures, the need for additional end finish can often be eliminated. The cut ends, supplied to specified embankment slopes, are furnished by the fabricator. Corrugated steel structures can be supplied with a step-bevel, bevel or a combination of skew and bevel.

It is recommended the embankment slope around the bevel or skew cut ends of a structure be protected against erosion and piping by riprapping around the structure end with stone, bags filled with dry sand-cement mixture, or by the use of a slope reinforcing pavement. See Figure 9.

The maximum angle permissible for unreinforced skew cut ends is dependent on the pipe's span (or for multiple runs, their combined span) as well as the fill slope. Greater spans or steeper fill slopes limit the degree of skew that can be used without reinforcement. When the permissible skew angle is exceeded, the cut ends must be reinforced with masonry, concrete headwalls or ring beams.





**Figure 9. Embankment erosion protection using bags filled with sand-cement mixture.**

For larger span structures or multiple runs, this limit needs to be viewed in regard to maintaining a reasonable balance of soil pressures from side to side, perpendicular to the structure(s) centerline. For single or multiple structures, the design engineer must provide the proper reinforcement and end protection in the plans and specifications.

Long bevels for slopes greater than 2:1 with or without skews, should be avoided. The long cut ends require extra care in design, erection and backfill. It is preferable to use a steep bevel without a skew and then warp the fill slope to fit the structure. Cut ends of corrugated steel structures, where the bevel exceeds 2:1 and/or the skew is greater than 15 degrees, should have the ends reinforced with masonry or concrete headwalls and anchored in accordance with specifications. More in depth information on design limits is provided in the *AISI Handbook of Steel Drainage and Highway Construction Products*.

### Cut-off Walls

Cut-off walls protect the structure from hydraulic uplift pressures below its invert and from dynamic flow forces. While cut-off walls are often unnecessary in small diameter applications, equalizer pipes, etc., larger structures,

pipes with a large bottom radius such as pipe arches or other pipes in applications where currents are swift or water levels rise or fall quickly are more susceptible to hydraulic damage. These latter conditions should be investigated by the design engineer.

## End Sections

End Sections provide a practical and economical method of finishing culverts. Sections are attached to the pipe or pipe arch ends by simple connectors—similar to coupling bands used in joining pipe sections—and can be completely salvaged if lengthening or relocating the culvert is necessary.

## Other End Finishes

While corrugated steel structures do not usually require headwalls, practically any type can be used. Where embankments must be confined, full or half-high steel sheeting headwalls are both efficient and economical. If required for appearance, concrete or masonry headwalls or half headwalls can also be used on all types of corrugated steel drainage structures. However, as is the case with rigid pipe, the headwalls must be supported by an adequate foundation.

## Stream Diversion

If the stream is temporarily diverted during construction, the diversion ditch or temporary drainage pipe must be adequate to carry the storm flow. Short construction times of course are helpful in limiting this exposure. The pipe installation must be protected from storm flows by a temporary dike, cofferdam, etc.

If the structure must carry the flow during the construction stage, the upstream end must be protected with the proper end treatment, etc. to ensure that the flow is not diverted around or beside the pipe thereby scouring out backfill as it is placed or floating the pipe. In phased construction, it is desirable to construct and backfill the upstream end first. (See Hydraulic Protection, page 38.)

## BACKFILLING

The load carrying capacity of any type of pipe is largely dependent upon proper backfilling. Corrugated steel pipes build up side support as they deflect under load.

Therefore to obtain maximum strength and prevent washing out and settlement, it is necessary that the backfill be made of good material, properly placed, carefully compacted and protected.

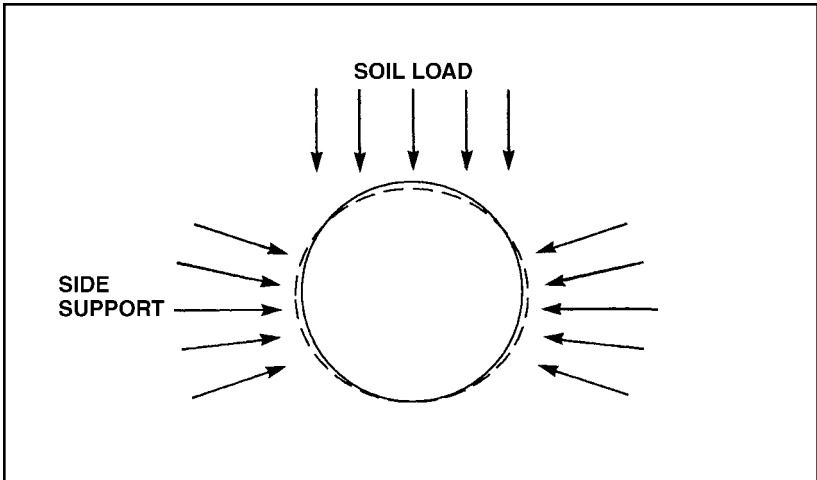


Figure 10. Pipe side support is developed by slight pipe deflection under load.

### Backfill Material

Selected, drainable materials achieve the best results. However, many local fill materials may do the job if carefully placed and compacted. Consult the design engineer or a soils engineer for proper backfill selection. Well graded granular material containing a small amount of silt or clay is ideal because it makes a dense, stable fill. Fill material must be free from rocks and hard earth clods larger than 3 inches (75 millimeters) in size. It must not contain any frozen material, sod, cinders or earth containing organic matter.

### Placing the Backfill

**Too much emphasis cannot be placed on the necessity of adequate compaction of backfill. Faulty compaction has led to more trouble with pipe installations, flexible and rigid, than all other factors combined!**

For trench installations, backfill must follow as closely behind the excavation and assembly stages as possible. Embankment installations typically are backfilled after the entire structure, or a major portion of it, is assembled. Unless the embankment and backfill materials are placed simultaneously, one must be benched so the other can be compacted against it.

The backfill should be carefully compacted under the haunches (lower part of structure exterior, below widest part); special care should be taken in doing this for pipe-arches.

Continue placing the backfill equally on both sides of the pipe in 6 to 8 inches (.15 to .20 meters) of compacted layers thoroughly compacting each layer to a 90% Standard Proctor density (AASHTO T99). Such compacted layers must extend to the limits shown on the plans on each side of the structure, or to the side of a trench, or to the natural ground line.

One problem in backfilling is the frequent inclination of installing crews to have the backfill material dumped in piles around the pipe. Such piles of material are seldom spread so that there is a maximum depth of a 6 to 8 inches (.15 to .20 meters) of compacted layer. If the filling crew works too fast, the compaction crew never has a chance to adequately compact the first material before more is placed in the trench. If backfill material is properly selected, well placed and then adequately compacted, there is little danger of anything going wrong with the installation. See Figure 11.

Backfill must be placed and fully compacted to the minimum cover level over the structure before the pipe is subjected to highway or light construction loads. **When construction equipment that exceeds legal highway loads will cross the pipe, an extra thickness of compacted fill, beyond that required for minimum or planned cover, is required. See Construction Loads, page 37.**

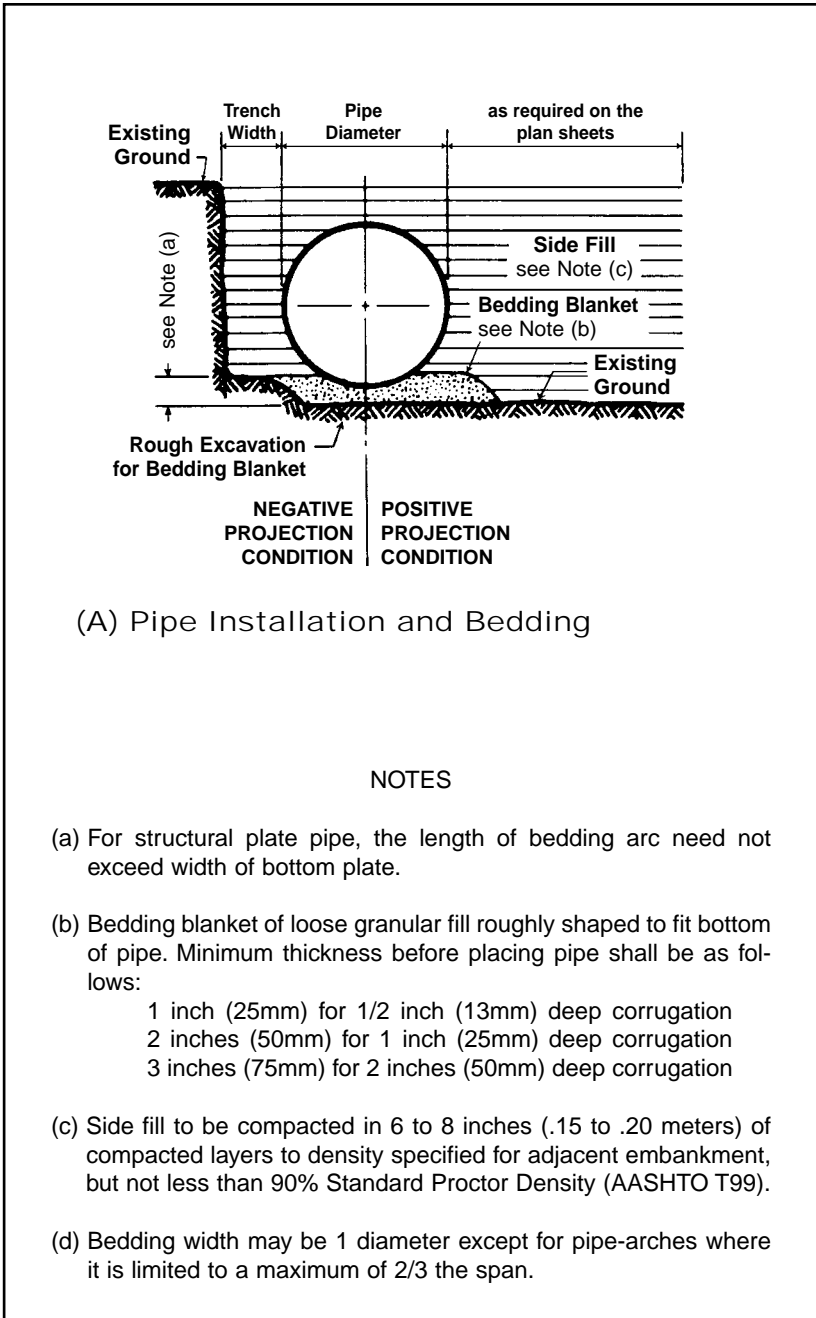


Figure 11. Bedding and Backfill Details.

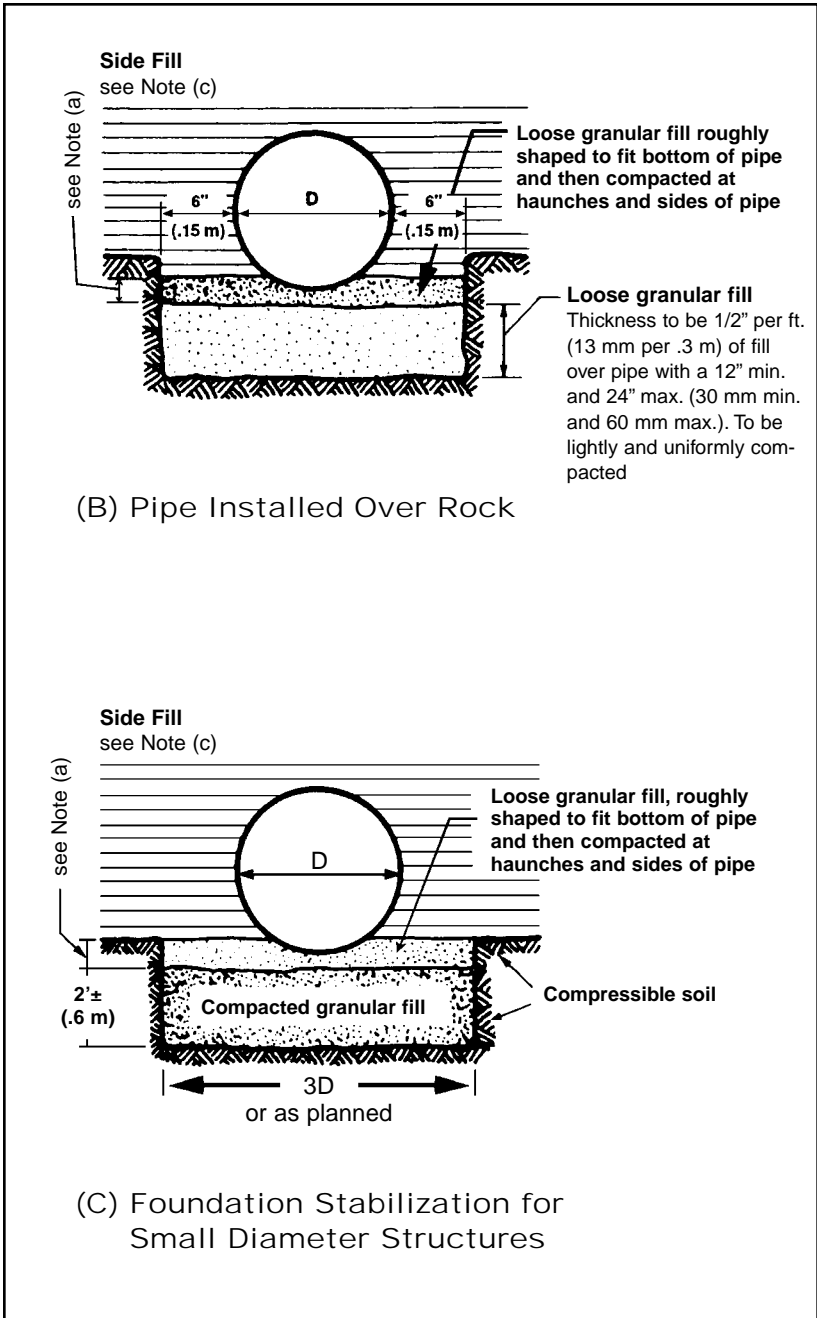


Figure 11. Bedding and Backfill Details (continued).

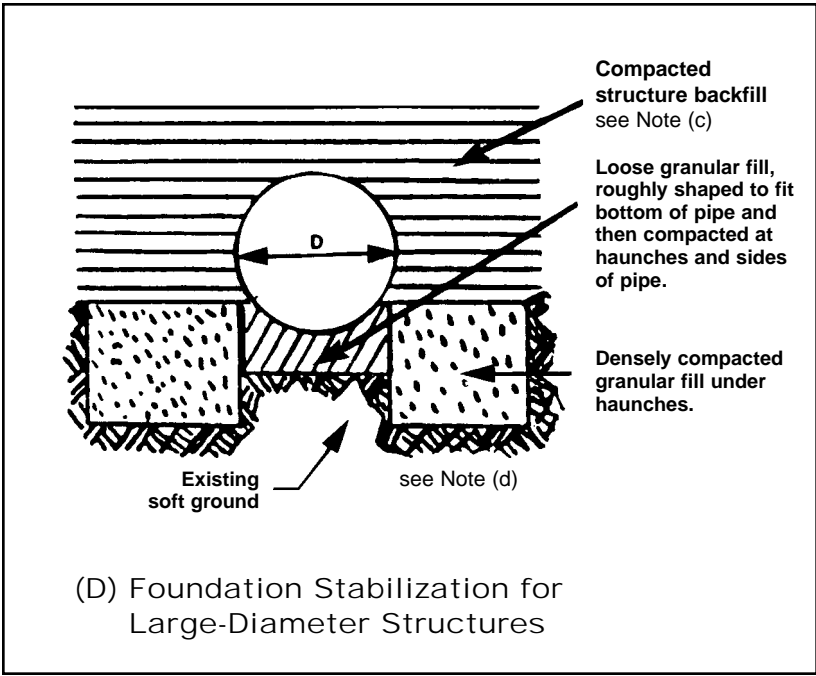


Figure 11. Bedding and Backfill Details (continued).

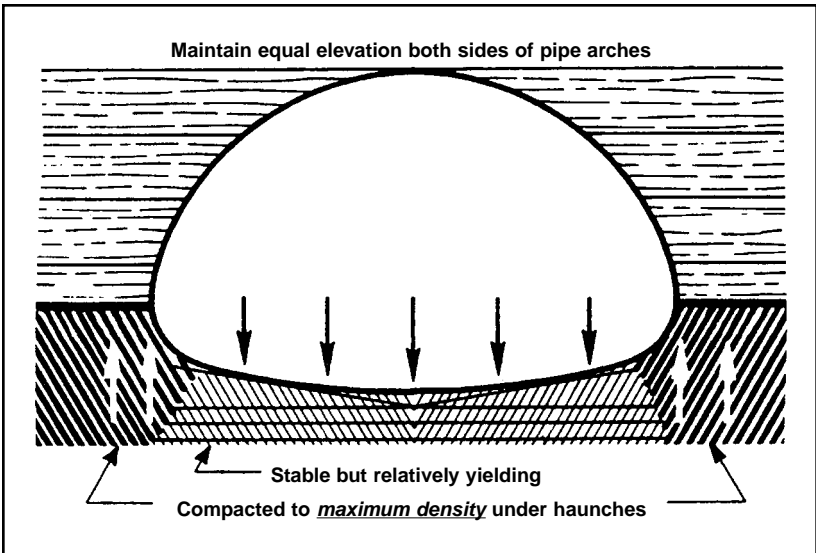


Figure 12. Recommended backfilling practice for larger pipe arch, using a vee-shaped bed.

## Pipe Arches

Special attention must be given to compaction of the backfill under the haunches of the pipe arch. A softer or yielding foundation under the bottom, as compared to the corners, is essential. See Figure 12. A vee-shaped bed for larger pipe arches is recommended.

### Arches

Care must be taken in backfilling arches, especially half-circle arches, because they have a tendency to shift sideways or to peak under backfilling loads. The ideal way is to cover an arch in layers—each layer conforming to the shape of the arch. If one side is backfilled more than the other, the arch will move away from the larger load. If both sides are backfilled equally and tamped thoroughly, the top of the arch may peak unless enough fill has been placed over it to resist the upward thrust. These precautions apply also to other corrugated steel structures, but to a lesser degree.

When backfilling arches before headwalls are placed, the first material should be placed midway between the ends of the arch, forming as narrow a ramp as possible until the top of the arch is reached. The ramp should be built evenly from both sides and the backfill material should be thoroughly compacted as it is placed. After the two ramps have been built to the depth specified to the top of the arch, the remainder of the backfill should be placed and compacted by extending the ramp both ways from the center to the ends, and as evenly as practicable on both sides of the arch.

If the headwalls are built before the arch is backfilled, the backfill material should first be placed adjacent to each headwall, placing and compacting material uniformly on both sides of the structure until the top of the arch is reached. Then backfill should proceed toward the center by extending the ramp; with care being taken to place and compact the material evenly on both sides of the arch. Top loading will help control peaking.

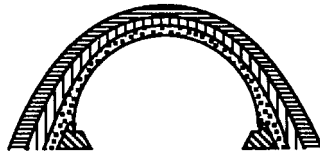




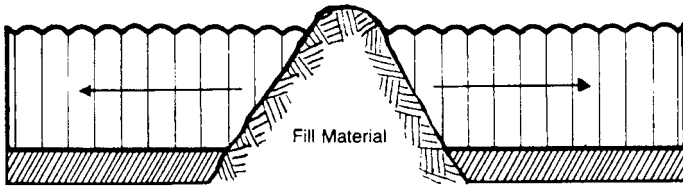
Filling on only one side causes arch to shift. If fill is not placed on top as backfilling proceeds, arch may raise, thereby flattening side radius.

COMMON MISTAKES IN BACKFILLING ARCHES (above)

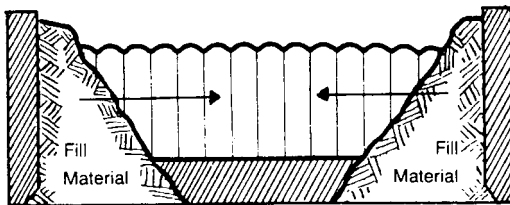
Place fill on arch by distributing material around and over the structure in uniform layers, tamping thoroughly.



RECOMMENDED BACKFILLING PRACTICE



SIDE VIEW—Without Headwalls



SIDE VIEW—With Headwalls

Figure 13. Recommended backfilling practice for structural plate arches.

## Large Diameter Structures (Embankment Installations)

Large diameter structures are not to be confused with Long Span Structures (see page 35).

### Proper Material Placement

The areas immediately next to the pipe must be compacted by hand-operated methods, although heavy compaction equipment may be brought quite close, (within 2 ft. (.6 m) in most embankment installations.) Changes in dimension or plumb of the structure warn that heavy machines must work further away.

Spread backfill material with equipment running parallel to, not at right angles to the structure.

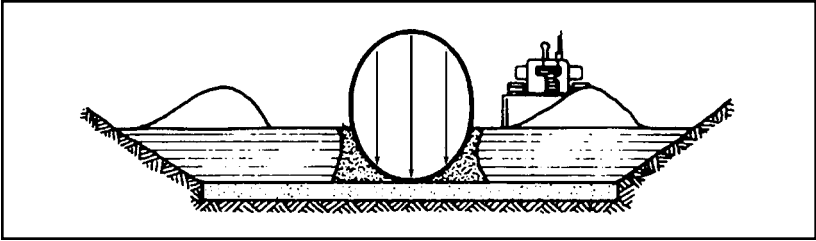


Figure 14. Hand compaction and heavy equipment procedure.

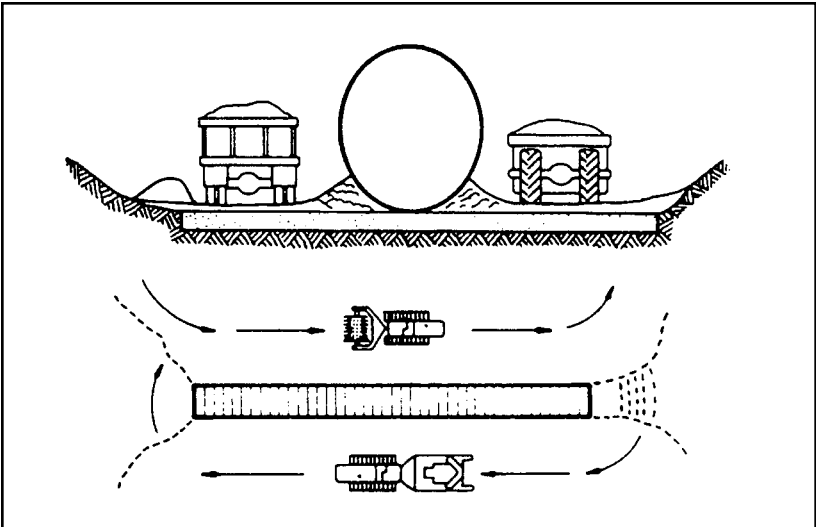


Figure 15. Proper material placement.

## Even Placement of Backfill

Compact the backfill by working parallel to, not against, the structure.

Place fill evenly on both sides. Peaking or rolling of the structure must be avoided. (Note discussion of shape control, page 33.)

For multiple installations, sufficient space between the pipes must be allowed for compaction equipment to operate properly (see Figure 16).

When the fill on both sides approaches the crown of the pipe, the same techniques of spreading shallow layers and compacting thoroughly must be followed as the fill covers the pipe. For the initial layers over the pipe, light hand or walk-behind compaction equipment is necessary.

After backfilling 2 ft. (.6 m) over the top or to a depth of 1/8th the span, whichever is greater, and the soil-steel structure is “locked-into-place,” then further filling to grade may continue using procedures applicable to embankment construction. For construction loads see page 36.

The bedding and backfill operation should be entirely conducted in the dry if at all possible, but with enough moisture to meet compaction standards. There are cases where large CSP are preassembled, and rolled or lifted into the stream bed “in and wet,” where it is not possible to build a cofferdam and divert the stream. Such conditions make it very difficult to ensure good base preparation and proper backfill. Strength consideration must be made by the designer in these cases, and expert advice obtained on backfill procedures.

## Shape Control

Shape control refers to controlling the symmetry of the structure during backfill by control of the backfill technique. Two movements may occur during backfilling “peaking,” caused by the pressure of the compaction of the sidefill, and sidewall distortion-caused by generating compaction forces on one side of the structure relative to the other.

Shape changes are limited by using proper backfill compaction procedures and equipment as well as backfill, material quality, gradation and moisture content. Special attention should be paid to maintaining the structure's rise dimensions, concentricity and smooth, uniform curvature.

The “plumb-bob” method of deflection control is most convenient and effective for large structures. Suspend plumb bobs from the shoulder (2 and 10 o'clock) positions so that the points are a specific vertical distance from a marked point on the invert at start of backfill.

Peaking or deflection action can be detected when the points of the bobs move vertically. Corrective action is usually to keep heavy equipment further away from the structure. Placing and compacting backfill in thinner lifts and/or bringing the backfill to the proper moisture content will reduce the necessary compactive effort and help to control peaking.

Rolling action can be detected when the plumb-bobs move laterally. It is corrected by filling or compacting on the side towards which the plumb-bob has moved. For example, a roll to the right will be corrected by higher fill on the right.

Careful observance of the deflection control plumb-bobs and prompt remedial steps prevents peaking or rolling action from distorting the structure.

### Multiple Structure Installations

Backfill must be balanced across all the structures at all times. Placement may require a hoe, stonebucket, conveyor or other device to assure that even pressure is felt on both sides of all the structures. The design should have provided adequate room between the structures to operate the equipment required for proper compaction of the backfill. Flowable fills that require no compaction effort can be used with minimal spacing between the pipes.

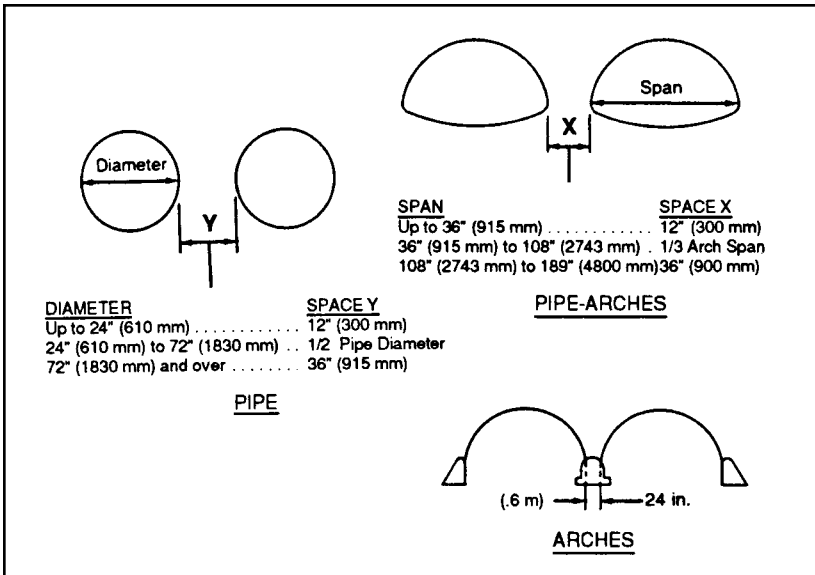


Figure 16. Minimum Spacing.

Recommended minimum spacings for pipe, pipe-arch and arches are shown in Figure 16. The spacings are for the use of all, standard backfill materials and allow room for compacting the backfill.

The minimum spacing shown also provides adequate room between the pipe and the trench wall for adequate material placement and compaction.

Whether the structure is large or small, keep in mind that the requirements of economical equipment should also be considered in determining spacing between the structures. For example, with structural plate structures it may be desirable to utilize mobile equipment for compaction between the structures. The space between pipes should allow efficient operation and selection of compaction equipment.

## Long Span Structures

Long span structures use only the best, non-plastic granular materials. Because of their size, the manufacturer will supply a shape control inspector to aid in the critical portion of the backfilling process. Specific backfill and placement requirements will be reviewed in the pre-construction conference.

## Final Backfilling

Once the envelope of backfill material is placed around and over the pipe and properly compacted, the remainder of the fill, the final backfill, should be placed and compacted to prevent settlement at the surface. The backfill material and compaction level specified has been selected to prevent surface subsidence, protect the pavement, etc.

When thick sheeting, such as wood, has been used to support the trench walls be sure to fill and compact the voids left when it is withdrawn or, cut it off above the crown of the pipe.

Final backfill is compacted by conventional methods. The use of water flooding or jetting should be limited to compacting soils which are sufficiently permeable to dispose of the excess water and should not be used with cohesive soils. However, final backfill can be compacted with fewer restrictions on materials and layer thickness than the backfill in the envelope around and immediately above the pipe.

## COMPACTION EQUIPMENT

---

### Hand Compaction

For compacting the small areas under the haunches of a structure, a pole or 2 x 4 (see note under Figure 1) is generally needed. Hand tampers for horizontal layers should weigh not less than 20 pounds (9 kilograms) and have a tamping face not larger than 6 by 6 inches (150 x 150 millimeters).

### Mechanical Compactors

Most types of power tampers are satisfactory in all except the most confined areas. However, they must be used carefully and completely over the entire area of each layer to obtain the desired compaction. Avoid striking the structure with power tamping tools.

### Roller Compactors

Where space permits, sheepfoot (recommended for clays and silts only), rubber tired and other types of rollers—with the exception of smooth rollers—can be used to compact backfill. But the fill adjacent to the structure should be tamped with hand or hand-held power equipment.

### Vibrating Compactors

Vibrating compactors can be used effectively on all types of backfill except heavy clays or other plastic soils. Small walk behind equipment is especially suited to trench installations.

### Hydraulic Compaction

The use of water flooding and/or jetting for compacting backfill around the pipe is limited to compacting clean, granular soils. To be effective, the foundation below the pipe must be sufficiently permeable to carry the water down and away quickly. Backfill around and immediately above the pipe must be placed and compacted in individual lifts of 6 to 8 inches (150 to 200 millimeters) of compacted thickness.

### Structure Protection

Often, construction loads exceed the finished design loads for the structure. Additionally, during the various phases of assembly, backfill and construction the structure typically is more vulnerable to loadings and hydraulic forces because its backfill, end treatment, etc. are not complete. The corrugated steel structure must be properly protected.

## Construction Loads

Frequently, it is necessary for heavy construction equipment to travel over installed corrugated steel structures during completion of grading, paving or other site work. Heavy construction equipment can impose concentrated loads far in excess of those the structure is designed to carry.

Adequate protection of the corrugated steel structure may require more than finished design fill. The amount of additional fill needed depends on the equipment axle loads as well as the frequency of use.

Figures 17 and 18 provide the minimum cover for typical structure sizes, axle loads and construction use. While providing extra cover is a simple way to protect the structure, it must be maintained so that rutting, surface grading, etc. does not reduce its effect. A minimum crossing width of 24 feet (7.3 meters) is recommended for typical equipment.

Pipe Span, in.	Minimum Cover (ft) for Indicated Axle Loads (thousands of pounds)*			
	18-50	50-75	75-110	110-150
12-42	2.0	2.5	3.0	3.0
48-72	3.0	3.0	3.5	4.0
78-120	3.0	3.5	4.0	4.0
126-144	3.5	4.0	4.5	4.5

\*Minimum cover may vary, depending on local conditions. The contractor must provide the additional cover required to avoid damage to the pipe. Minimum cover is measured from the top of the pipe to the top of the maintained construction roadway surface.  
 \*In unpaved situation, the surface must be maintained.

**Figure 17. Minimum Cover.**

Pipe Span, mm.	Minimum Cover (m) for Indicated Axle Loads (metric tons)*			
	8-23	23-34	34-50	50-68
305-1067	.6	.8	.9	.9
1219-1829	.9	.9	1.0	1.2
1981-3048	.9	1.0	1.2	1.2
3200-3658	1.0	1.2	1.4	1.4

\*Minimum cover may vary, depending on local conditions. The contractor must provide the additional cover required to avoid damage to the pipe. Minimum cover is measured from the top of the pipe to the top of the maintained construction roadway surface.  
 \*In unpaved situation, the surface must be maintained.

**Figure 18. Metric equivalent of Figure 18.**



**Figure 19. Compacted side fill should be completed on both sides of structure before fill is "carried over" for construction traffic.**

Temporary dead loads resulting from storage piles, crane placements, etc. must be evaluated as to structure capacity, loading balance, backfill support, adequate foundation strength, and other factors that may be applicable to the conditions.

### Hydraulic Protection

During installation, prior to the completion of backfilling, permanent end treatment, slope protection, flow controls, etc., the structure is vulnerable to storm and flow conditions less than the final design levels. Hydraulic flow forces on unprotected ends, unbalanced backfill loads, loss of backfill and support due to erosion and uplift forces are examples of factors to be considered. While guidance is offered in some of the above sections, temporary protection may need to be constructed.

Hydraulic forces can float in complete structures without protection or buckle inverts (large radius inverts are especially vulnerable to buckling) if the foundation, bedding or backfill becomes saturated. Proper channeling of flow through active structures, placing end treatment and slope protection as early as possible are advised. Protecting cofferdammed structures and trench installations from ponding



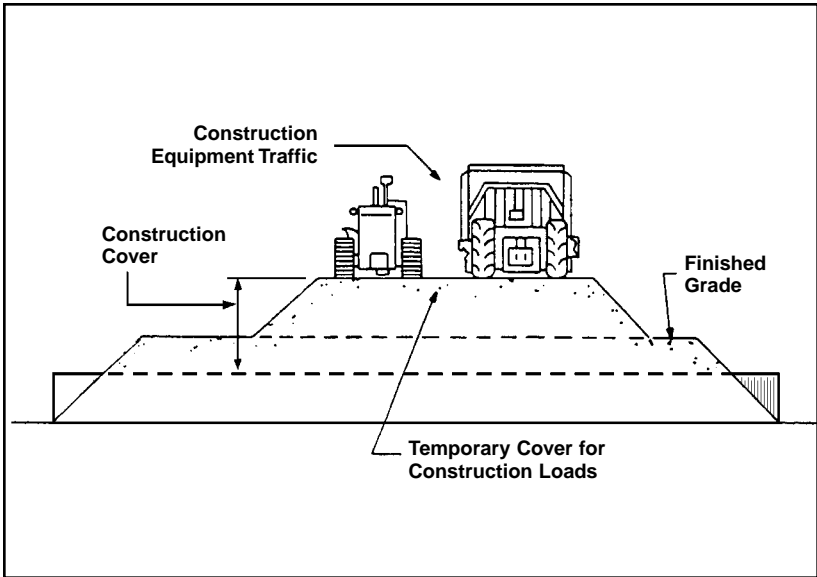


Figure 20. Minimum cover for construction leads.



Adequate, uniform compaction is the secret to building soil and steel structures.

## SUMMARY

---

Proper installation of any drainage structure will result in longer and more efficient service. This installation manual is intended to call attention to both good practice and to warn against possible pitfalls. The principles apply to most conditions. It is not a specification but an aid to your own experience.

The following items should be checked to insure proper installation:

- 1) Check alignment in relation to the plans as well as the actual site conditions.**
- 2) Make certain the pipe length(s), necessary appurtenances, etc. are correct.**
- 3) Excavate to the correct width, line and grade.**
- 4) Provide a uniform, stable foundation—correct site conditions as necessary.**
- 5) Unload, handle and store the pipe correctly.**
- 6) Assemble the pipe properly check alignment, follow special procedures for the connecting bands, gaskets, and other hardware used. (For structural plate structures, achieve properly aligned plate laps, bolt torque, and assembled dimensions.)**
- 7) Use a suitable (granular) backfill material as required in the plans and specifications.**
- 8) Maintain proper backfill width.**
- 9) Haunch the pipe properly.**
- 10) Place and compact the backfill in 6 to 8 inches (150 to 200 millimeters) of thickness of compacted lifts.**
- 11) Install the necessary end treatment quickly to protect the pipe and your efforts.**
- 12) Protect the structure from heavy construction equipment loads, other heavy loads and hydraulic forces.**

## SUBDRAINAGE

---

### Underdrain Pipe

Underdrains, to remove ground water, must be properly installed to give long, satisfactory service. With perforated steel underdrain pipe, correct installation is fast and easy.

### Flow Line

The flow line should be placed below water-bearing strata for most effective drainage. However, if the strata is too deep to permit draining to a natural outlet, the pipe can be placed within the water-bearing material if this would permit natural drainage or a sump pump may be used. This does not provide complete drainage but will lower the natural water table to a desirable level. Outlets should be free and not subject to flooding or restriction by freezing or debris and protected against damage by maintenance equipment.

Where possible, it is desirable to use a 0.2 percent minimum slope for all subdrainage lines.

### Preparing the Foundation

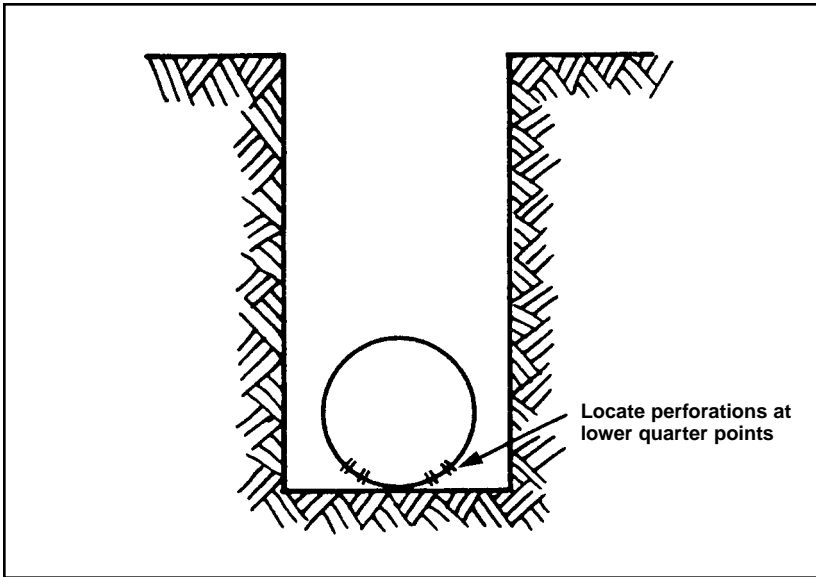
Underdrain pipe should be laid on a stable foundation. If the bottom of the trench can be set below the water-bearing strata and the pipe placed in an impervious layer, the foundation will generally be stable. But if the pipe must be located in water-bearing strata, it may be necessary to stabilize the bottom of the trench by placing granular material under the pipe. However, corrugated steel underdrains will hold alignment on soft foundations much better than rigid or plastic pipes. Steel pipe is supplied in much longer lengths and thus diminishes the hazards of disjoints, settlement, and loss of alignment.

### Assembly of Underdrain Pipe

Assembly or installation of a subdrainage system is usually started at the downstream or outlet end to allow ground water to drain out of the trench, keeping it reasonably dry during construction.

If not specified, pipe perforations should be positioned at the lower quarter points, as shown in Figure 21. Placing holes in this position lowers the water table efficiently while reducing the tendency of filter material or silt to flow into the pipe.

Connecting bands for helically corrugated perforated pipe (usually supplied



**Figure 21. Correct placement of perforated steel underdrains.**

for small diameter drains) may be in two pieces with matching corrugations to fit this helically corrugated steel pipe or sleeve bands.

### Proper Placement of Underdrain

Subdrain material must permit ready flow of water while acting as a filter to keep fine soil from entering and clogging the subdrain system. Proper grading will help prevent backfill from being carried into the pipe.

Many bank-run sands and concrete sand will make a satisfactory backfill for perforated steel underdrains. Also, material having not more than 10% of its weight in particles larger than 3/8-inch (9.5 millimeter) will also make a satisfactory backfill.

This backfill material should be placed for a width of at least 6 inches (150 millimeters) on each side of the pipe and for the depth over the pipe necessary to intercept all possible water-bearing strata. Above this area the trench could be capped with other normal types of backfill material.

To control settlement, subdrain backfill should be placed in layers and well compacted. A geotextile may be used to prevent infiltration of fines, particularly at the joint.

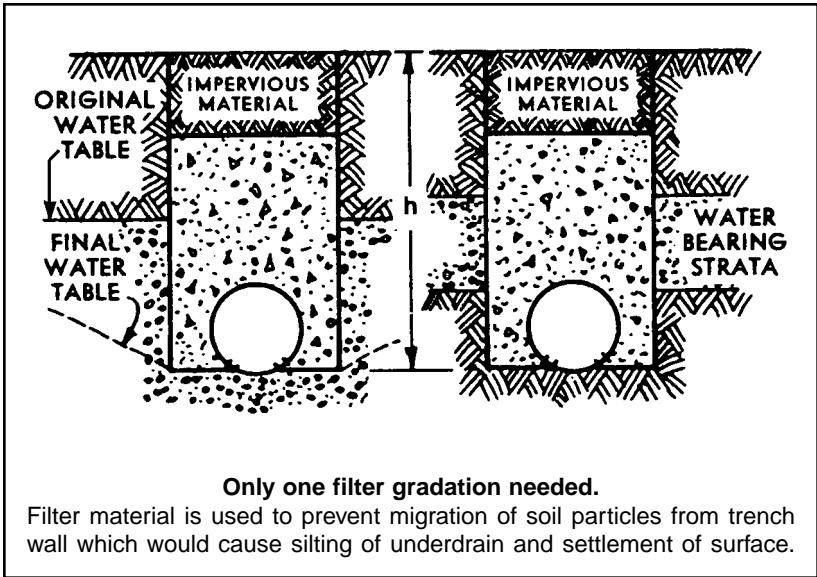


Figure 22. Corrugated steel pipe underdrain.

## APPENDIX

### Culvert Grades and Outfall Treatment

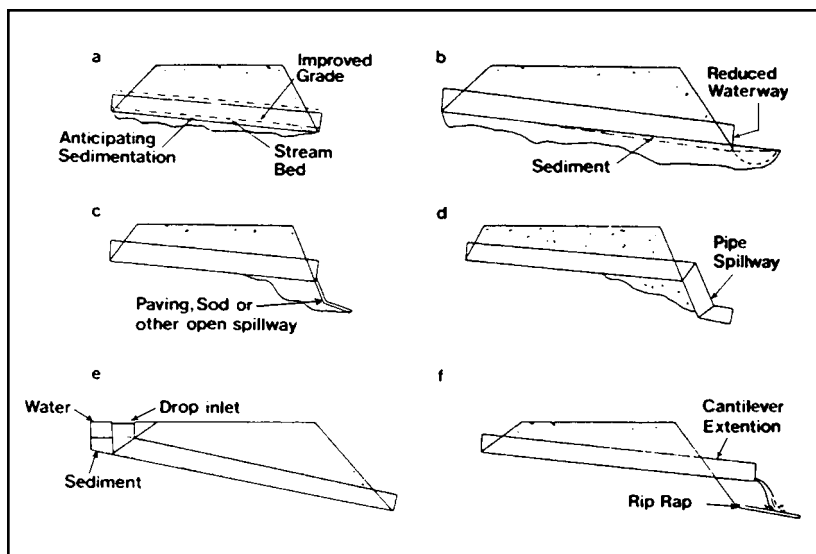


Figure 23. Methods of obtaining correct culvert grade.

### Length of Culverts

Length of a culvert depends upon roadway width from shoulder to shoulder height of fill above flow line, side slope of the embankment, as well as alignment and grade.

Where culverts are to be installed at right angles to the road, their length can be computed by the method presented in Figures 24 and 25. Note that when culverts are on steep grades, their centers are offset with respect to roadway centerline.

In calculating length of skewed culverts (those at less than 90 degree angle to roadway centerline), length must be increased according to skew angle (See page 46).

Lengths of corrugated steel pipe and structural plate pipe are normally supplied in even increments of 2 ft. (.6 meter).

In order to obtain the correct skew cut on a pipe, use Figure 27 to determine the proper skew number to give the manufacturer.

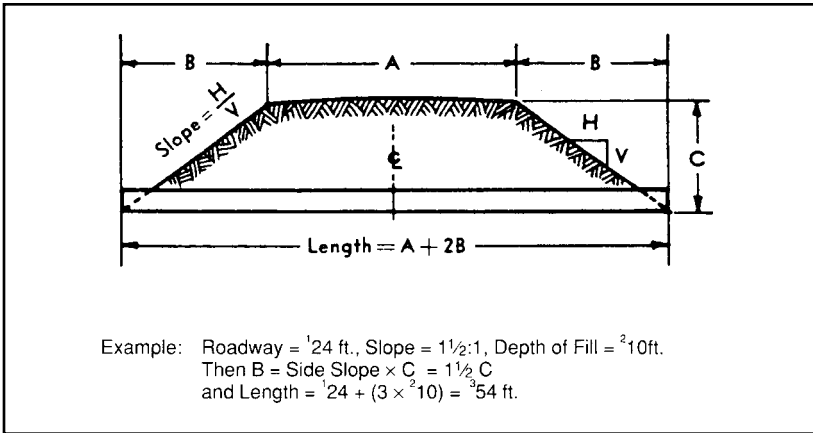


Figure 24. Computation of culvert length-flow line on flat grade.

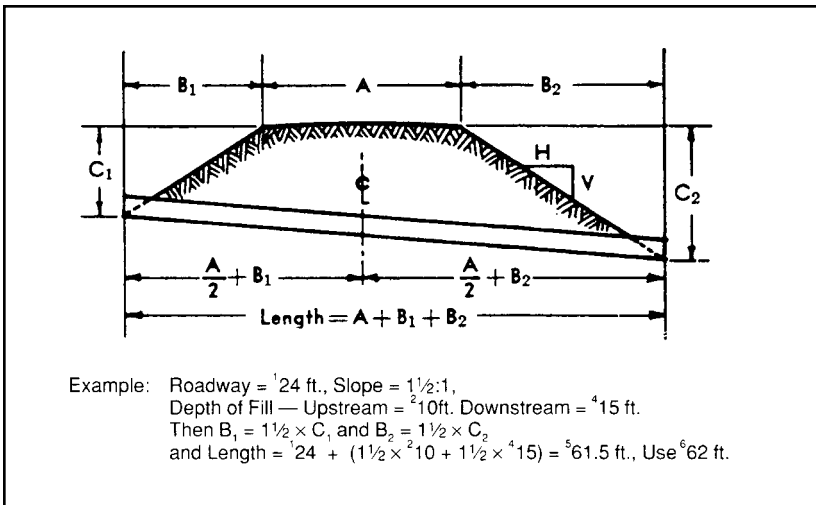
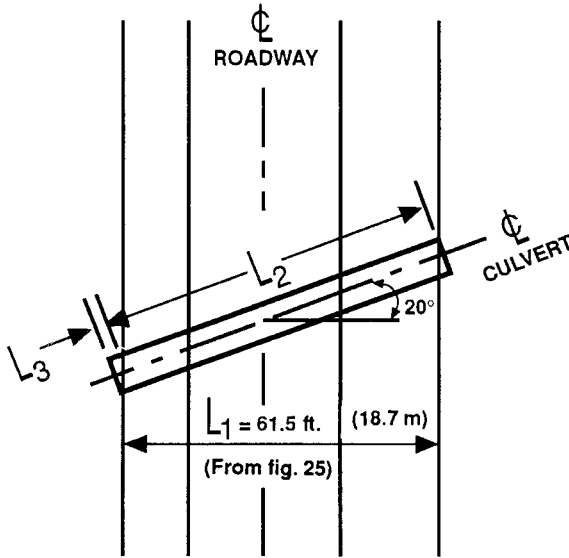


Figure 25. Computation of culvert length-flow line on steep grade.

**Note:** Superior numbers 1 to 6 in figures 24 and 25 are to be ignored in working the examples. They are to convert the examples to metric values as follows.

- <sup>1</sup> is 7.3 m
- <sup>2</sup> is 3 m
- <sup>3</sup> is 16.3 mm
- <sup>4</sup> is 4.6 m
- <sup>5</sup> is 18.7 m
- <sup>6</sup> is 19 m



**PLAN VIEW**

Use example in Figure 25, but the pipe is skewed  $20^\circ$  to the roadway (i.e., cross  $20^\circ$  off the perpendicular). The pipe is 4 ft. (1220 mm) in dia.

$$\begin{aligned} L1 &= \text{actual culvert length for no skew} \\ &= 61.5 \text{ ft. (18.7m) (from Figure 25)} \end{aligned}$$

$$L2 = \frac{L1}{\cos \text{skew}\angle} = \frac{61.5}{\cos 20^\circ} = 65.4 \text{ ft. (19.9m)}$$

$$\begin{aligned} L3 &= \text{pipe span} \times \tan \text{skew}\angle \\ &= 4 \times \tan 20^\circ = 4 \times 0.364 = 1.46 \text{ ft. (.45m)} \end{aligned}$$

$$\begin{aligned} \text{Length} &= L2 + L3 = 65.4 + 1.46 = 66.86 \text{ ft. (20.3m)} \\ &\text{use } 68 \text{ ft. (20.5m)} \end{aligned}$$

**Figure 26. Computation of culvert length skewed to the roadway embankment.**



### Skew Number

In order to obtain the correct skew cut on a pipe, use Figure 27 to determine the proper skew number to give the manufacturer.

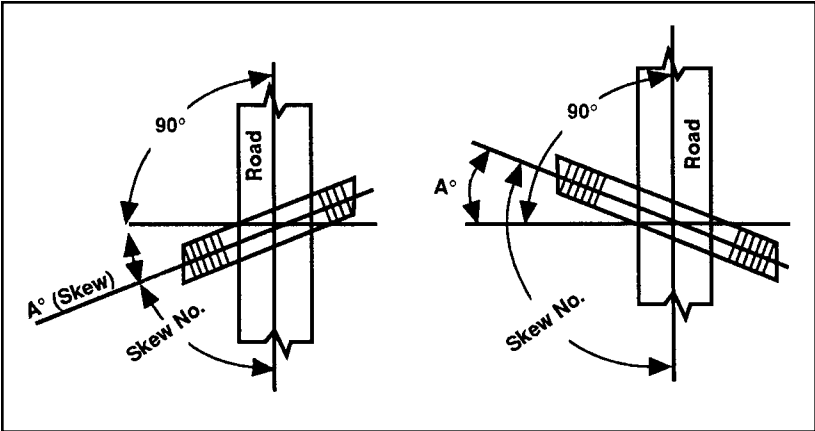


Figure 27.





NATIONAL CORRUGATED STEEL PIPE ASSOCIATION

1255 Twenty-Third Street, NW, Suite 200

Washington, DC 20037-1174

Phone: 202/452-1700 • Fax: 202/833-3636

E-mail: [csp@ncspa.org](mailto:csp@ncspa.org) • Web: [www.ncspa.org](http://www.ncspa.org)